

The Principles of Noncontact Temperature Measurement

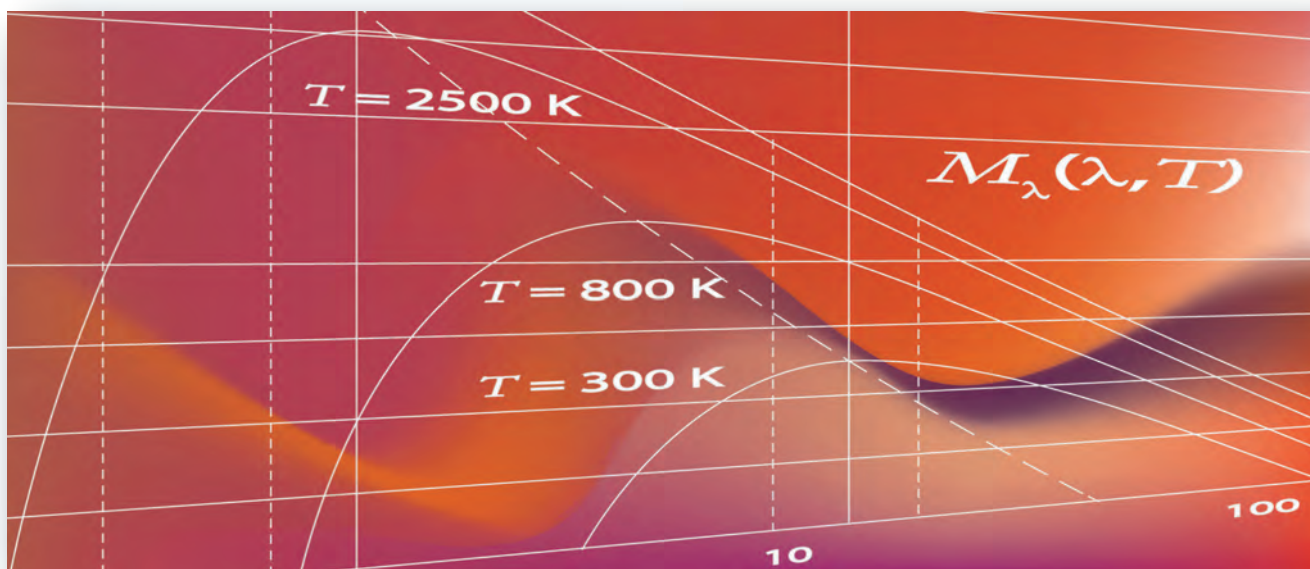

Infrared Theory

Content

CONTENT
1 INTRODUCTION
2 DISCOVERY OF INFRARED RADIATION
3 ADVANTAGES OF USING INFRARED THERMOMETERS.....
4 THE INFRARED SYSTEM
4.1 The Target	4
4.1.1 Determining Emissivity.....	6
4.1.2 Measuring Metals	7
4.1.3 Measuring Plastics	7
4.1.4 Measuring Glass.....	7
4.2 Ambient Conditions.....	8
4.3 Optics and Window	10
4.4 Sighting Devices	12
4.5 Detectors.....	13
4.6 Display and Interfaces.....	13
4.7 Technical Parameters of IR Thermometers.....	14
4.8 Calibration	15
5 SPECIAL PYROMETERS	1
5.1 Fiber-optic Pyrometers	16
5.2 Ratio Pyrometers.....	16
5.3 Imaging Systems.....	18
5.3.1 IR Linescanners.....	18
5.3.2 Matrix Cameras.....	20
6 SUMMARY	2
7 BIBLIOGRAPHY	2

1 Introduction

This booklet is written for people who are unfamiliar with noncontact infrared temperature measurement. A conscious attempt has been made to present the subject matter as briefly and as simply as possible. Readers who wish to gain more in-depth knowledge can follow the suggestions for further reading in the bibliography. This manual focuses on the practical operations of noncontact temperature measurement devices and IR thermometry, and answers important questions that may arise. If you plan to use a non-contact temperature measurement device and require further advice, send us the completed form (see appendix) prior to use.

2 Discovery of Infrared Radiation

Fire and ice, hot and cold – elemental extremes have always fascinated and challenged people. Various techniques and devices have been used throughout time in an effort to accurately measure and compare temperature conditions. For example, in the early days of ceramics manufacture, meltable materials were used, which indicated through deformation that certain higher temperatures were reached. A baker on the other hand, used a piece of paper – the quicker it became brown in the oven, the hotter the oven was. The disadvantage of both of these techniques was that they were not reversible – cooling could not be determined. Also, the accuracy of the results was very dependent on the user and his or her experience. It was not until the invention of the first thermoscope in the first half of the 17th Century that temperatures could begin to be measured. An evolution of the thermoscope (which had no scale) the thermometer had various scales proposed. Between 1724 and 1742 Daniel Gabriel Fahrenheit and by Anders Celsius defined what we probably consider as the 2 most common.



Fig. 1: William Herschel (1738 – 1822) discovers IR radiation

The discovery of infrared radiation by the physicist Wilhelm Herschel at the beginning of the 19th Centu-

ry opened up new possibilities for measuring temperature – without contact and thus without affecting the object being measured and the measurement device itself. Compared to early infrared temperature measurement devices, which were heavy, awkward and complicated to operate, the image of such devices today has completely changed. Modern infrared thermometers are small, ergonomic, easy to operate and can even be installed into machinery. From versatile handheld devices to special sensors for integration into existing process systems, the spectrum of product offerings is vast. A variety of accessories and software for the collection and analysis of measurement data are provided with the majority of infrared temperature sensors.

3 Advantages of Using Infrared Thermometers

Temperature is the most frequently measured physical parameter, second only to time. Temperature plays an important role as an indicator of the condition of a product or piece of machinery, both in manufacturing and in quality control. Accurate temperature monitoring improves product quality and increases productivity. Downtimes are decreased since the manufacturing processes can proceed without interruption and under optimal conditions. Infrared technology is not a new phenomenon. It has been utilized successfully in industry and research for decades. But new developments have reduced costs, increased reliability, and resulted in smaller noncontact infrared measurement devices. All of these factors have led to infrared technology becoming an area of interest for new kinds of applications and users.



Fig. 2: Digital Infrared Pyrometer in miniature size (Raytek MI3 Series)

What are the advantages offered by noncontact temperature measurement?

1. It is fast (in the ms range) – time is saved, allowing for more measurements and accumulation of more data (temperature areas can be determined).
2. It facilitates measurement of moving targets (conveyor processes).
3. Measurements can be taken of hazardous or physically inaccessible objects (high-voltage parts, large measurement distances).
4. Measurements of high temperatures (above 1300°C) present no problems. Contact thermometers often cannot be used in such conditions, or they have a limited lifetime
5. There is no interference as no energy is lost from the target. For example, in the case of a poor heat conductor such as plastic or wood, measurements are extremely accurate with no distortion of measured values, as compared to measurements with contact thermometers.
6. Noncontact temperature measurement is wear-free – there is no risk of contamination and no mechanical effect on the surface of the object. Lacquered or coated surfaces, for example, are not scratched and soft surfaces can be measured.

Having enumerated the advantages, there remains the question of what to keep in mind when using an IR thermometer:

1. The target must be optically (infrared-optically) visible to the IR thermometer. High levels of dust or smoke make measurement less accurate. Solid obstacles, such as a closed metallic reaction vessel, do not allow internal measurements.
2. The optics of the sensor must be protected from dust and condensing liquids. (Manufacturers supply the necessary equipment for this.)
3. Normally, only surface temperatures can be measured, with the differing emissivities of different material surfaces taken into account.

Summary

The main advantages of noncontact IR thermometry are speed, lack of interference, and the ability to measure in high temperature ranges up to 3000°C. Keep in mind that generally only the surface temperature can be measured.

4 The Infrared System

An IR thermometer can be compared to the human eye. The lens of the eye represents the optics through which the radiation (flow of photons) from the object reaches the photosensitive layer (retina) via the atmosphere. This is converted into a signal that is sent to the brain. Fig. 3 shows how an infrared measuring system works.

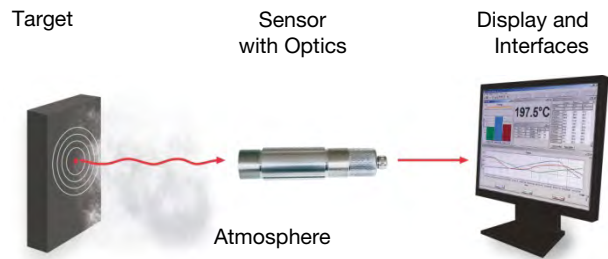

Fig. 3: Infrared Measuring System

4.1 The Target

Every form of matter with a temperature (T) above absolute zero (-273.15°C / -459.8°F) or emits infrared radiation according to its temperature. This is called characteristic radiation. The cause of this is the internal mechanical movement of molecules. The intensity of this movement depends on the temperature of the object. Since the molecule movement represents charge displacement, electromagnetic radiation (photon particles) is emitted. These photons move at the speed of light and behave according to the known optical principles. They can be deflected, focused with a lens, or reflected by reflective surfaces. The spectrum of this radiation ranges from 0.7 to 1000 μm wavelength. For this reason, this radiation cannot normally be seen with the naked eye. This area lies within the red area of visible light and has therefore been called "infra"-red after the Latin, see Fig. 4.

Fig. 5 shows the typical radiation of a body at different temperatures. As indicated, bodies at high temperatures still emit a small amount of visible radiation. This is why everyone can see objects at very high temperatures (above 600°C) glowing somewhere from red to white. Experienced steelworkers can even estimate temperature quite accurately from the color. The classic disappearing filament pyrometer was used in the steel and iron industries from 1930 on.

The Infrared System

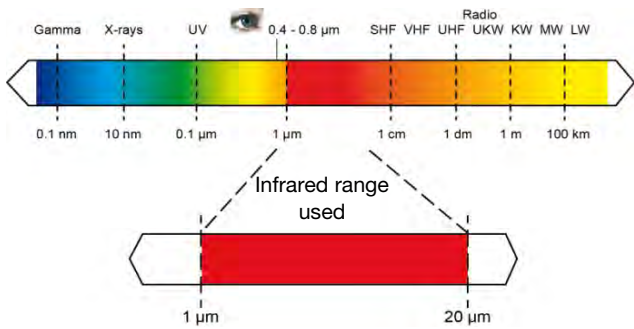

Fig. 4: The electromagnetic spectrum, with range from around 1 to 20 μm useful for measuring purposes

The invisible part of the spectrum, however, contains up to 100,000 times more energy. Infrared measuring technology builds on this. It can likewise be seen in Fig. 5 that the radiation maximum move toward ever-shorter wavelengths as the target temperature rises, and that the curves of a body do not overlap at different temperatures. The radiant energy in the entire wavelength range (area beneath each curve) increases to the power of 4 of the temperature. These relationships were recognized by Stefan and Boltzmann in 1879 and illustrate that an unambiguous temperature can be measured from the radiation signal. /1/, /3/, /4/, /5/

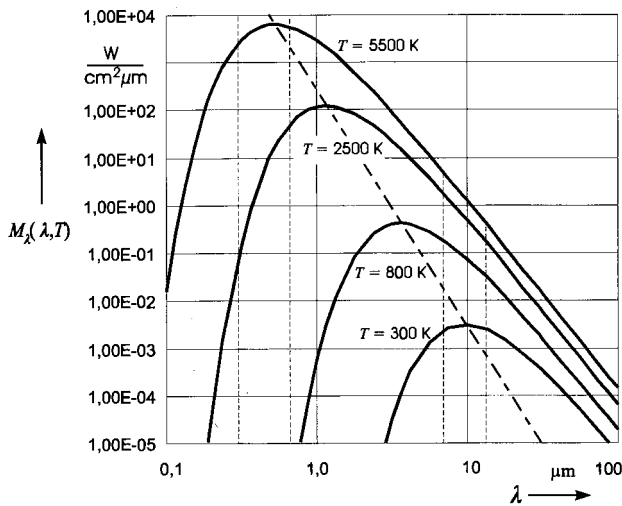

Fig. 5: Radiation characteristics of a blackbody in relation to its temperature./3/

Looking at Fig. 5, then, the goal should be to set up the IR thermometer for the widest range possible in order to gain the most energy (corresponding to the area below a curve) or signal from the target. There are, however, some instances in which this is not always advantageous. For instance, in Fig. 5, the intensity of radiation increases at 2 μm – much more

when the temperature increases than at 10 μm. The greater the radiance difference per temperature difference, the more accurately the IR thermometer works. In accordance with the displacement of the radiation maximum to smaller wavelengths with increasing temperature (Wien's Displacement Law), the wavelength range behaves in accordance with the measuring temperature range of the pyrometer. At low temperatures, an IR thermometer working at 2 μm would stop at temperatures below 600°C, seeing little to nothing since there is too little radiation energy. A further reason for having devices for different wavelength ranges is the emissivity pattern of some materials known as non-gray bodies (glass, metals, and plastic films). Fig. 5 shows the ideal—the so-called "blackbody". Many bodies, however, emit less radiation at the same temperature. The relation between the real emissive power and that of a blackbody is known as emissivity ε (epsilon) and can be a maximum of 1 (body corresponds to the ideal blackbody) and a minimum of 0. Bodies with emissivity less than 1 are called gray bodies. Bodies where emissivity is also dependent on temperature and wavelength are called non-gray bodies.

Furthermore, the sum of emission is composed of absorption (A), reflection (R) and transmission (T) and is equal to one. (See Equation 1 and Fig. 6)

$$A + R + T = 1 \quad (1)$$

Solid bodies have no transmission in the infrared range (T = 0). In accordance with Kirchhoff's Law, it is assumed that all the radiation absorbed by a body, and which has led to an increase in temperature, is then also emitted by this body. The result, then, for absorption and emission is:

$$A \leftrightarrow E = 1 - R \quad (2)$$

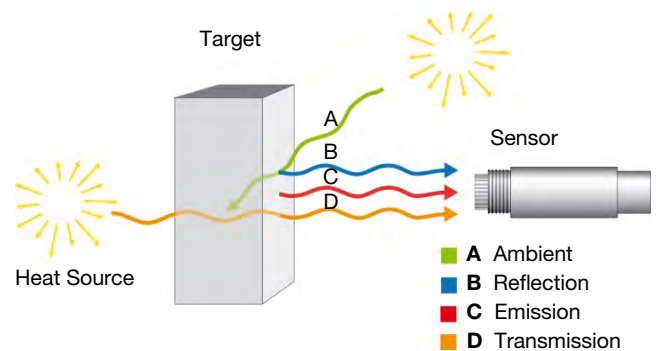

Fig. 6: In addition to the radiation emitted from the target, the sensor also receives reflected radiation and can also let radiation through.

The ideal blackbody also has no reflectance ($R = 0$), so that $E = 1$.

Many non-metallic materials such as wood, plastic, rubber, organic materials, rock, or concrete have surfaces that reflect very little, and therefore have high emissivities between 0.8 and 0.95. By contrast, metals - especially those with polished or shiny surfaces - have emissivities at around 0.1. IR thermometers compensate for this by offering variable options for setting the emissivity factor, see also Fig. 7.

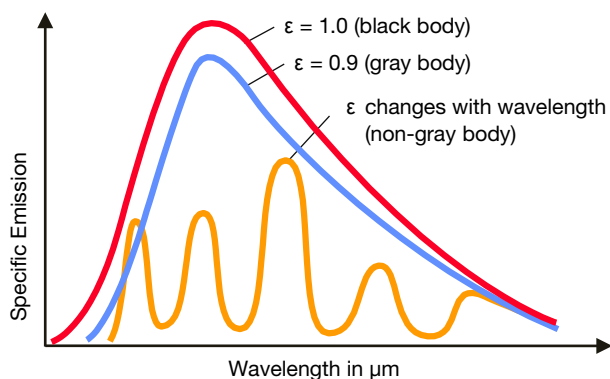

Fig. 7: Specific emission at different emissivities

4.1.1 Determining Emissivity

There are various methods for determining the emissivity of an object. So you can find the emissivity of many frequently used materials in a table. Emissivity tables also help you find the right wavelength range for a given material, and, so, the right measuring device. Particularly in the case of metals, the values in such tables should only be used for orientation purposes since the condition of the surface (e.g. polished, oxidized or scaled) can influence emissivity more than the various materials themselves. It is also possible to determine the emissivity of a particular material yourself using different methods. To do so, you need a pyrometer with emissivity setting capability.

1. Heat up a sample of the material to a known temperature that you can determine very accurately using a contact thermometer (e.g. thermocouple). Then measure the target temperature with the IR thermometer. Change the emissivity until the temperature corresponds to that of the contact thermometer. Now keep this emissivity for all future measurements of targets on this material.
2. At a relatively low temperature (up to 260°C), attach a special plastic sticker with known emissivity to the target. Use the infrared measuring device to determine the temperature of the sticker and the corresponding emissivity. Then measure the surface temperature of the target without the sticker and re-set the emissivity until the correct temperature value is shown. Now, use the emissivity determined by this method for all measurements on targets of this material.
3. Create a blackbody using a sample body from the material to be measured. Bore a hole into the object. The depth of the borehole should be at least five times its diameter. The diameter must correspond to the size of the spot to be measured with your measuring device. If the emissivity of the inner walls is greater than 0.5, the emissivity of the cavity body is now around 1, and the temperature measured in the hole is the correct temperature of the target /4/. If you now direct the IR thermometer to the surface of the target, change the emissivity until the temperature display corresponds with the value given previously from the blackbody. The emissivity found by this method can be used for all measurements on the same material.
4. If the target can be coated, coat it with a matte black paint ("3-M Black" from the company 3M or "Senotherm" from Weilburger Lackfabrik (Grebe Group)/2/, either which have an emissivity

The Infrared System

of around 0.95). Measure the temperature of this blackbody and set the emissivity as described previously.

4.1.2 Measuring Metals

The emissivity of a metal depends on wavelength and temperature. Since metals often reflect, they tend to have a low emissivity which can produce differing and unreliable results. In such a case it is important to select an instrument which measures the infrared radiation at a particular wavelength and within a particular temperature range at which the metals have the highest possible emissivity. With many metals, the measurement error becomes greater with the wavelength, meaning that the shortest wavelength possible for the measurement should be used, see Fig. 8.

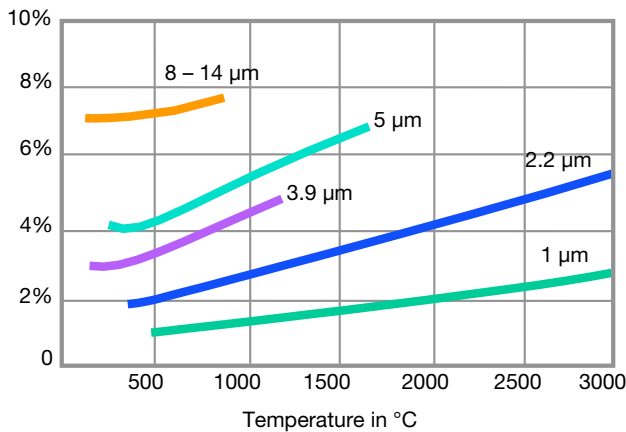

Fig. 8: Measurement error in the case of 10% error in setting emissivity dependent on wavelength and target temperature.

The optimal wavelength for high temperatures in the case of metals is, at around 0.8 to 1.0 μm, at the limit to the visible range. Wavelengths of 1.6, 2.2, and 3.9 μm are also possible. Good results can be achieved using ratio pyrometers in cases (e.g. heating processes) where measurement is to take place across a relatively wide temperature range and the emissivity changes with the temperature.

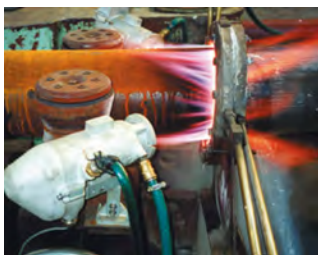

Fig. 9: Accurate temperature measurement of slabs, billets, or blooms ensures product uniformity

4.1.3 Measuring Plastics

The transmittance of a plastic varies with the wavelength and is proportional to its thickness. Thin materials are more transmissive than thick plastics. In order to achieve optimal temperature measurement it is important to select a wavelength at which transmittance is nearly zero. Some plastics (polyethylene, polypropylene, nylon, and polystyrol) are not transmissive at 3.43 μm; others (polyester, polyurethane, Teflon FEP, and polyamide) at 7.9 μm. With thicker (> 0.4 mm), strongly-colored films, you should choose a wavelength between 8 and 14 μm.

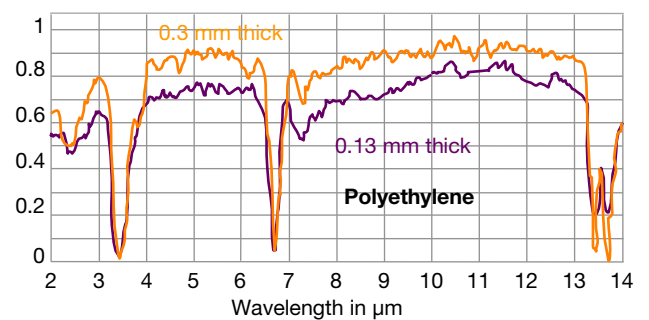

Fig. 10: Spectral transmittance of plastic films. Independent of thickness, Polyethylene is almost opaque at 3.43 μm.

If you are still uncertain, send a sample of the plastic to the manufacturer of the infrared device to determine the optimal spectral bandwidth for measurement. A lot of plastic films have reflectance of about 5%.

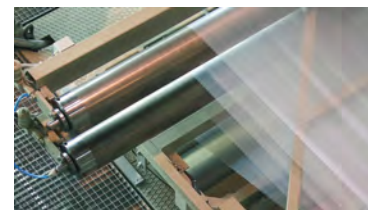

Fig. 11: Non-contact infrared temperature measurement of film extrusion, extrusion coating, and laminating

4.1.4 Measuring Glass

When measuring the temperature of glass with an infrared thermometer, both reflectance and transmittance must be considered. By carefully selecting the wavelength, it is possible to measure temperature of both the surface and at a depth.

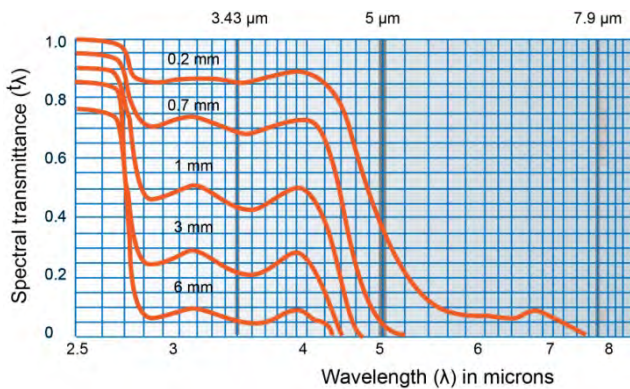

Fig. 12: Spectral transmittance of glass depending on thickness

When taking measurements below the surface, a sensor for 1.0, 2.2, or 3.9 μm wavelength should be used. We recommend you use a sensor for 5 μm for surface temperatures or 7.9 μm for surface temperatures for very thin sheets or low temperatures. Since glass is a poor conductor of heat, and can change surface temperature rapidly, a measuring device with a short response time is recommended.



Fig. 13: From the molten state through to the cooling process, continuous temperature monitoring ensures that glass retains its properties as it travels through the manufacturing process, here the tempering of glass sheets

Summary

Every body emits infrared radiation. This radiation is only visible to the naked eye at temperatures above 600°C (e.g. glowing-hot iron). The wavelength range is from 0.7 μm to 1000 μm . Blackbodies absorb and emit 100% of the radiation that corresponds to their characteristic temperature. All other bodies are placed in relation to this when evaluating their radiation emission. This is called emissivity.

4.2 Ambient Conditions

Another reason for setting up an IR thermometer for a particular spectral range only (spectral radiation pyrometer), is the transmission behavior of the transmission path, usually the ambient air. Certain components of the atmosphere, such as vapor and carbon dioxide, absorb infrared radiation at particular wavelengths which result in transmission loss. If absorption media is not taken into account, it can lead to a temperature displayed below that of the actual target temperature. Fortunately, there are "windows" in the infrared spectrum which do not contain these absorption bands. In Fig. 14 the transmission curve of a 1 m long air distance is represented. Typical measuring windows are 1.1–1.7 μm , 2–2.5 μm , 3–5 μm and 8–14 μm . Since the manufacturers have already furnished infrared measuring devices with atmospheric correction filters, the user is spared such worries.

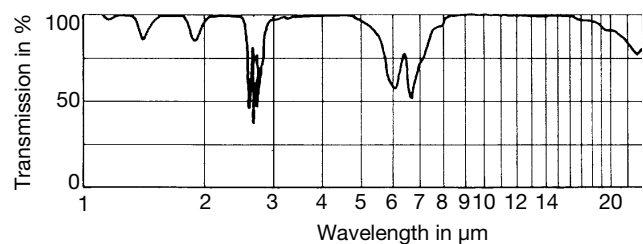

Fig. 14: Transmittance of a 1 m long air distance at 32°C and relative 75% humidity./3/

Thermal radiation in the environment surrounding the target should likewise be taken into account. The higher temperatures of the furnace walls could lead to errors in temperature measurement on metal pieces in an industrial furnace. The possible effect of the ambient temperature has been taken into consideration by many infrared measuring devices, with compensation built in. The other possibility is a too-high temperature being displayed for the target. A correctly set emissivity, along with automatic ambient temperature compensation from a second temperature sensor ensures extremely accurate results.

The Infrared System

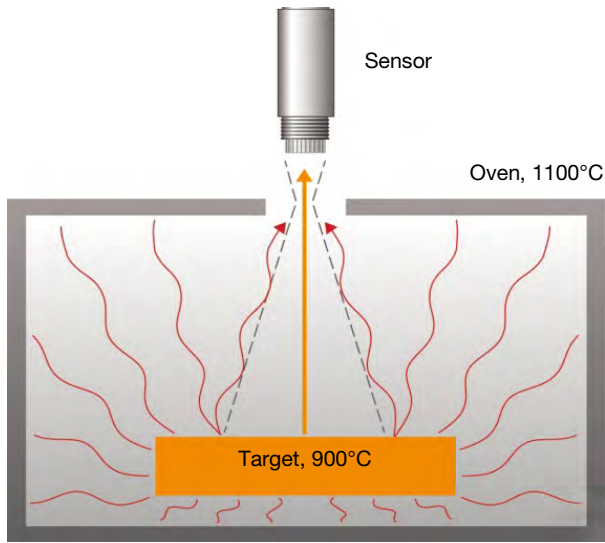

Fig. 15: Ambient temperature compensation is important where targets are cooler than the surrounding environment.

Dust, smoke, and suspended matter in the atmosphere can result in contamination of the optics and, therefore, in false measured values. In order to prevent deposition of suspended matter, optional air-blowing attachments are offered. These are usually screw-on pipe connections with a compressed air supply. The air ensures overpressure in front of the optics, thus keeping contaminating particles at bay. If a great amount of dust or smoke is created during the measurement procedure and affect the result, then ratio pyrometers should be used.

IR sensors are electronic devices and can only work within certain operating temperature ranges. Some sensors allow an upper limit of 85°C. Above the permitted operating temperature, air or water-cooling accessories must be used and there must be special connection cables for the application of high temperature. When using water-cooling it is often useful to use it in conjunction with the air-blowing attachment to prevent formation of condensation on the optics.

Summary

Factors	Solution
<ul style="list-style-type: none"> Ambient radiation is hotter than target 	<ul style="list-style-type: none"> Sensor with ambient radiation compensation Shielding of target background
<ul style="list-style-type: none"> Dust, vapor, particles in the atmosphere 	<ul style="list-style-type: none"> Air-blowing unit for lens Ratio pyrometer
<ul style="list-style-type: none"> High operating temp. 	<ul style="list-style-type: none"> Thermally insulated assembly Water or air-cooling Air-blowing unit for lens Heat shield

4.3 Optics and Window

The optical system of an infrared thermometer picks up the infrared energy emitted from a circular measurement spot and focuses it on a detector. The target must completely fill this spot, otherwise the IR thermometer will "see" other temperature radiation from the background making the measured value inaccurate, see Fig. 16.

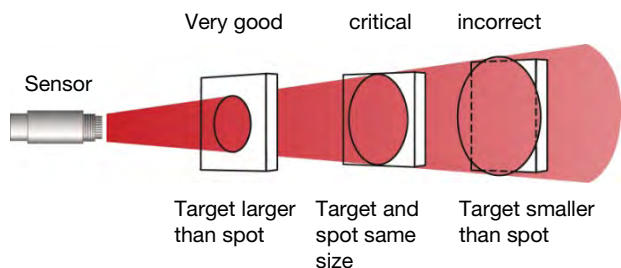

Fig. 16: The target must completely fill the spot to be measured, otherwise the measured value will be incorrect (exception: ratio pyrometer).

The optical resolution is defined as the relationship between the distance of the measuring device from the target, and the diameter of the spot (D:S). The greater this value, the better the optical resolution of the measuring device, and the smaller the target can be at a given distance, see Fig. 17.

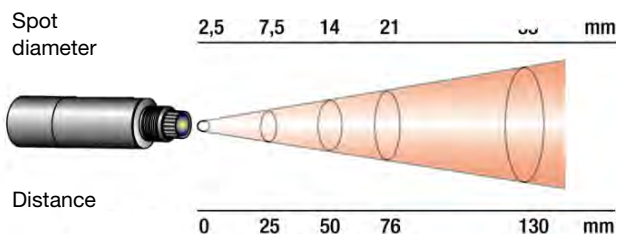

Fig. 17: Optical diagram of an infrared sensor. At a distance of 130 mm the spot measured is 33 mm, giving a ratio of around 4:1.

The optics themselves can be mirror optics or lens optics. Lenses can only be used for particular wavelength ranges due to their material wavelength ranges. They are, however the preferred solution for reasons of design. As a rule the optics is a so-called fixed focus optics, i.e. the focal point is at a vendor-defined measurement distance and only there the D:S ratio indicated in the data sheet applies. Of course, the pyrometer measures correctly at each other measuring distance, however, the D:S ratio will be slightly impaired. Here the tables and/or charts indicated in the instruction manual of the device

should be carefully consulted. In terms of technology optics offering a variable distance setting are the better solution, since here the user can always choose the maximum D:S value.

Fig. 18 shows a device with manual distance setting. Via a button on the device or via remote control using the digital interface a servomotor receives the respective commands.



Fig. 18: Pyrometer featuring a variable distance setting – Raytek MM series with variable focus. The variable focus can be controlled manually on-site or remotely via the digital interface. Among others a video camera is used as a aiming device precisely marking the spot also when the measurement distance is changed.

Table 1 shows some typical lenses and window materials for IR thermometers, along with their wavelength ranges./3/

For measurement in a closed reaction vessel, furnace, or vacuum chamber, it is usually necessary to measure through a suitable measuring window. When selecting a material for the window, keep in mind that the transmission values of the window are tuned to the spectral sensitivity of the sensor. At high temperatures, the material most often used is quartz glass. At low temperatures (in the range 8–14 μm), it is necessary to use a special IR-transmissive material such as germanium, Amtir, or Zinc Selenide. When choosing the window, consider the spectral sensitivity parameters, diameter of the window, temperature requirements, maximum window pressure difference, and ambient conditions as well as the possibility of keeping the window free from contamination on both sides. It is also important to have transparency in the visible range in order to be able to align the device better with the target (e.g. in a vacuum container).

The transmittance of the window greatly depends upon its thickness. For a window with a diameter of 25 mm, (which should be able to withstand the

The Infrared System

pressure difference of one atmosphere), a thickness of 1.7 mm is adequate.

Windows with an anti-reflecting layer exhibit much higher transmittance (up to 95%). If the manufacturer states the transmittance for the corresponding wavelength range, the transmission loss can be corrected along with the emissivity setting. For example, an Amtir window with 68% transmittance is used to measure a target with emissivity of 0.9. Then 0.9 is multiplied by 0.68, resulting in 0.61. This is the emissivity value to be set on the measuring device.

	Recommended IR wavelength range	Maximum window temp	Transmission in visible range	Resistance to damp, acids, ammonia compounds	Suitable for UHV
Sapphire Al_2O_3	1...4 μm	1800°C	yes	very good	yes
Fused silica SiO_2	1...2.5 μm	900°C	yes	very good	yes
CaF_2	2...8 μm	600°C	yes	poor	yes
BaF_2	2...8 μm	500°C	yes	poor	yes
AMTIR	3...14 μm	300°C	nein	good	-
ZnS	2...14 μm	250°C	yes	good	yes
ZnSe	2...14 μm	250°C	yes	good	yes
KRS5	1...14 μm	-	yes	good	yes

Table 1: Overview of various window materials

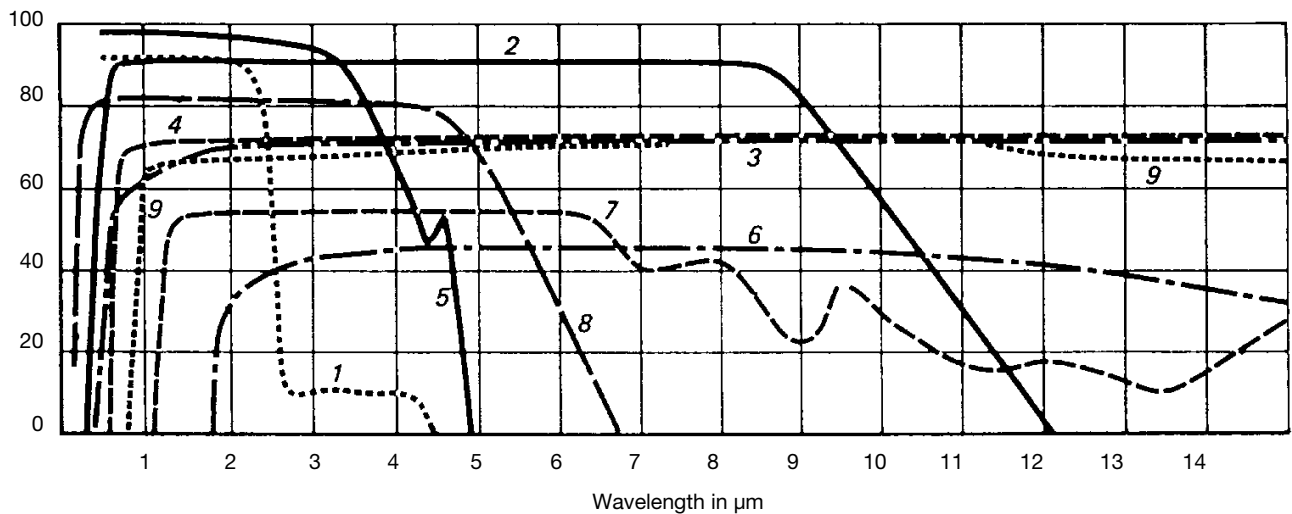

- | | | |
|--------------------------|----------------|---------------------------|
| 1 Optical glass | 4 KRS5 | 7 Silizium |
| 2 Calcium fluoride (CaF) | 5 Quartz glass | 8 Lithium fluoride |
| 3 Zinc Selenide (ZnSe) | 6 Germanium | 9 Chalcogenide glass IG-2 |

Fig. 19: Transmittance of typical IR materials (1 mm thick)

4.4 Sighting Devices

Pyrometers are often fitted with an integrated aligning telescope for directly optically aiming at the spot. Sighting devices with video cameras and connected displays simplify this task for the user and/or allow the regular control of the pyrometer position also from a control station. Moreover pyrometers can be fitted with lasers that are either built-in or screwed in front of the device. The laser beam enables the user to aim at the measuring spot even more quickly and precisely, which considerably simplifies the handling, in particular of portable IR measuring devices. In particular, it is very useful to sight on the measuring spot with a laser for the measurement of moving objects and in poor light conditions.

One can distinguish between the following laser sighting setups:

A Laser beam

... with an offset from the optical axis. This is the simplest model, especially for devices with low optical resolution (for big measuring objects). The laser spot aims approximately at the center of the measuring object, but there is a noticeable error at close range.

B Coaxial laser beam

This laser beam comes out of the center of the optics and remains along the optical axis. The center of the measuring spot is precisely marked at any measuring distance.

C Dual laser

Twin laser with two aiming points can be used to show the diameter of the measuring spot over a long distance. With this, the user does not need to guess the size of the diameter or calculate it beforehand. Furthermore it prevents the user from making mistakes during the measurement. The IR and laser spot diameters are not the same at close distances. The distance between the laser beams is slightly greater than the spot being measured. This prevents the user from making full use of the geometrical resolution stated for this device.

D Crossed laser

The crossed laser is special version of the dual laser and is used for sensors with dedicated focal point. The distance at which the two laser dots overlap is the point where the smallest area is measured (Focus Point).

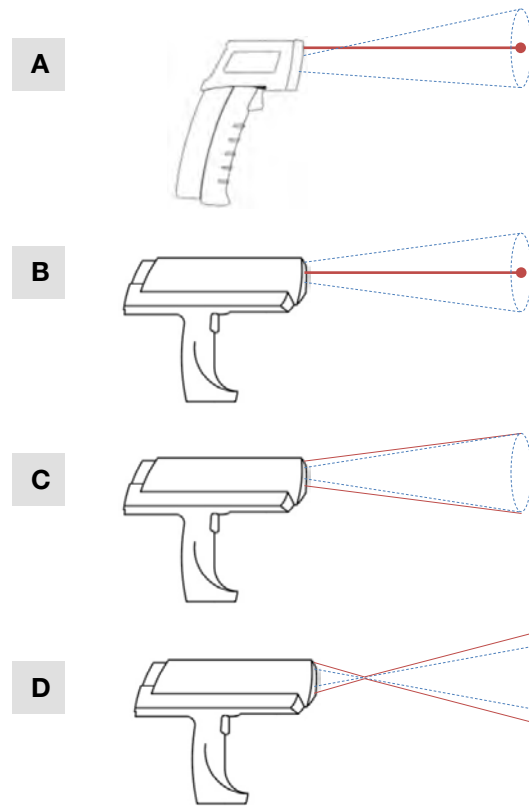

Fig. 20: Laser sighting

The use of the laser measuring spot proves to be an effective visual help in guiding the infrared measuring device precisely to the measuring object. The application of an aligning telescope is useful only for the determination of the measuring area when optically aimed at bright objects (at high temperatures) or to make measurements in strong daylight or at long distances.



Fig. 21: Devices with laser sighting allow a precise spot measurement even of small objects (Raytek 3i Series)

The Infrared System

Summary

Just as with a camera, the performance of the optics (e.g. telephoto lens), determines what size target can be viewed or measured. The distance ratio (distance from object: diameter of spot) characterizes the performance of the optics in an IR measuring device. The projected spot must be completely filled for an exact measurement of the target to result. For easier alignment, the optics are equipped with a through-the-lens or laser sighting device. A through-the-lens sighting device can be complemented by a built-in video camera thus facilitating remote monitoring. If protective windows between the measuring device and the target are necessary, the right window material must be chosen. In this case, wavelength range and operating conditions play a significant role.

4.5 Detectors

The detector forms the core of the IR thermometer. It converts the infrared radiation received into electrical signals, which are then emitted as temperature values by the electronic system. In addition to reducing the cost of IR thermometers, the most recent developments in processor technology have meant increases in system stability, reliability, resolution, and measurement speed.

Infrared detectors fall into two main groups: quantum detectors and thermal detectors. Quantum detectors (photodiodes) interact directly with the impacting photons, resulting in electron pairs and therefore an electrical signal. Thermal detectors (e.g. thermopiles or bolometers) change their temperature depending upon the impacting radiation. The temperature change creates a voltage change in the thermopile and a change in resistance in the bolometer. Thermal detectors are much slower than quantum detectors due to the self-heating required. (Here, much slower means ms in relation to ns or μ s of the latter detectors.) Quantum detectors are used above all for very fast imaging systems and line scanners.

4.6 Display and Interfaces

The interfaces and types of measured value displays available are important to the user. Some devices,

especially hand-held ones, have a directly accessible display and control panel combination which can be considered the primary output of the measuring device. Analog or digital outputs control the additional displays in the measuring station or can be used for regulating purposes. It is also possible to connect data loggers, printers, and computers directly.

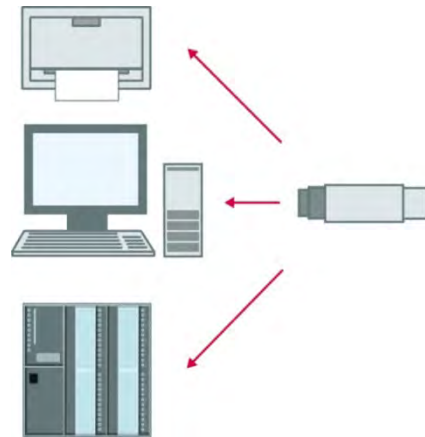

Fig. 22: The data outputs of the IR thermometer can be connected directly to printer or programmable logic controllers (PLC). Customer-specific graphics and tables can be created using PC software.

Industrial field bus systems are becoming ever more significant and afford the user greater flexibility. For example, the user can set the sensors from a control station without having to interrupt the manufacturing process. It is also possible to change parameters when different products are running on the same production line. Without such remote setting options, any change to the sensor parameters - emissivity, measuring range, or limit values - would have to be made manually at the sensor itself. Since the sensors are often mounted at difficult-to-access points, the intelligent sensor ensures continuous monitoring and control of the process with minimal input from personnel. If a malfunction occurs - ambient temperature too high, interrupted supply, component failure - an error message will appear automatically.

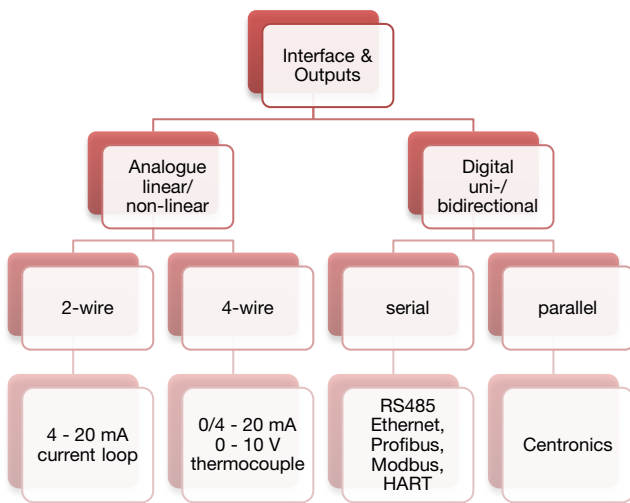

Fig. 23: Examples of interfaces in current infrared measuring devices (except Centronics).

The addressability of pyrometers facilitates operation of a number of devices on one network (multi-drop operation), resulting in lower installation costs. With the multiplicity of bus protocols and types of field bus now available, there are different converters (gateways) on the market which perform the task of converting (translating) device-specific commands into the appropriate protocol (e.g. Profibus PD). The RS485 is the most-used hardware platform in this respect.

Also used are devices with an Ethernet interface that have their own IP address and thus can be directly accessed via a standard Web browser in an intranet/internet. Here, applications for fast online measurements at defined intervals are problematic in network setups.

A further advantage of the pyrometer with a digital interface is that it allows field calibration using calibration software available from the device manufacturer.

4.7 Technical Parameters of IR Thermometers

A complete summary including the related notes on maintenance and validation measurement methods can be found in /6/, /7/ and /8/.

The following important technical parameters characterize radiation thermometers and should be taken into account in the selection of the appropriate pyrometer:

Measurement temperature range

The temperature range defined by the manufacturer of the device where the measurement drift will not exceed defined limits.

Measurement uncertainty

Tolerance interval in which the true measurement value lies at a specified probability, related to a given measurement and ambient temperature.

Temperature drift

The temperature drift is the additional measurement error caused by a deviation of the ambient temperature from the measurement uncertainty reference temperature, e.g. 0.01 K/K for an ambient temperature of >23 °C.

Temperature resolution

(Noise-equivalent temperature difference)

Share of the measurement uncertainty caused by device-inherent noise. This parameter is expressed using the defined response time and the measurement temperature, e. g. 0.1 K (at 100°C measurement temperature and 150 ms response time).

Repeatability

Share of the measurement uncertainty of measurements which are repeated within a short period of time under the same conditions.

Long-term stability

Is expressed in the same way as the measurement uncertainty, but relates to a longer period of time (several months).

Spectral range

For broad-band spectral pyrometers the upper and lower limits are indicated in μm ; for narrow-band spectral pyrometers the mean wavelength and a half-width, e. g. $5 \mu\text{m} \pm 0.5 \mu\text{m}$, are indicated.

Size of the measuring area

(depending on measurement distance)

Usually the size of the measurement area is indicated at which the signal has dropped to a certain val-

The Infrared System

ue, e.g. 90%. This includes the indication of the measurement distance. Alternatively the distance ratio (distance versus spot size, D:S) can be indicated.

Response time

Period of time elapsed between a change in temperature of the target and the related display of the measurement value. Complete details include the size of the sudden temperature change as well as the limit at which the measurement is made.

Example: $t = 10 \text{ ms}$ (25°C , 800°C , 95%)

Acquisition time

Minimum period of time during which a target needs to be visible to the measuring device so that the returned value can follow the measured value. A delayed display of the measurement value is possible. As a rule the acquisition time is shorter than the response time. The same details are indicated as for the response time.

Example: $t = 1 \text{ ms}$ (25°C , 800°C , 95 %)

Operating and storage temperatures

The admissible ambient temperature at which the device may be operated or stored.

In addition, mechanical and electrical operating conditions of the devices need to be observed (type of protection, vibration resistance, etc).

4.8 Calibration

Pyrometers should be regularly checked and, in case of deviations, newly calibrated, in order to guarantee their long-term accuracy. To do so, the respective institution (e.g. the accredited laboratory) needs to know the manufacturer's calibration geometry, or the application geometry of the device will be used. The most important parameters are the measurement distance and the measurement area of the calibration body and/or the size of the target. If a readjustment is required the device should be returned to the manufacturer or the user may use the field calibration software, if available, supplied by some manufacturers with the device.

Connection of the calibration bodies to the ITS90 is made, depending on the design, via reference pyrometers (transfer standard) or contact thermometers, which need to be calibrated at regular intervals at the competent accredited laboratories. The methods are described in detail in /9/.



Fig. 24: Calibration of a black body using a transfer standard pyrometer, Raytek TRIRAT LT

Raytek TRIRAT LT ¹	
Temperature	Measurement uncertainty 2σ
-49,9°C	0,11 K
-20,0°C	0,08 K
0,0°C	0,07 K
25,1°C	0,07 K
50,1°C	0,07 K
100,0°C	0,08 K
150,0°C	0,17 K
200,0°C	0,18 K
250,0°C	0,20 K
270,0°C	0,21 K

¹ Calibration certificate No.: 2034 PTB 02, opening diameter of the radiation source: 60 mm, calibration in the focal point, ambient temperature of $23^\circ\text{C} \pm 1^\circ\text{C}$

Table 2: Indicating the temperature values and the related measurement uncertainties of the transfer standard

5 Special Pyrometers

5.1 Fiber-optic Pyrometers

Pyrometers with fiber optics are used for applications involving strong electrical or magnetic interference fields for measurements at high ambient temperatures, under vacuum conditions or where only little space is available. This makes it possible to place the sensitive electronic system outside the danger zone. Typical of these applications are induction heating and induction welding. Since the fiber optics themselves contain no electronic components, the operating temperature can be raised significantly without the need for cooling (up to 300°C). Installation and continuous operating costs per measuring point are low since no water cooling is required.

Single fibers or multifiber bundles are used. Multifiber bundles have the advantage of allowing a smaller bending radius.

With modern devices, it is possible to replace the fiber-optic cable and optics without recalibration. Simply input a multi-digit factory calibration number. Fiber-optics are available for wavelengths of 1µm and 1.6µm. Targets from 250°C can be measured with these.



Fig. 25: Modern digital fiber-optic pyrometer (Raytek Marathon FR)

5.2 Ratio Pyrometers

Special pyrometers (also called two-color or dual wavelength pyrometers) have two optical and electrical measuring channels identical in structure. Both wavelength ranges are placed as close as possible to each other and set very narrow-banded, so that the effect of material-specific peculiarities (reflectance, emissivity) from the target is near-identical to both wavelengths. By means of a mathematical calculation of ratio, certain influences on measurement can be eliminated. The following procedures have proved successful:

1. Splitting the measured radiation using two filters which revolve in front of a radiation detector (filter wheel). Measurement in both channels takes place alternately which, in the case of fast-moving targets, can result in errors in ratio calculation (channel 1 sees a different point on the target than channel 2).
2. Splitting of the measured radiation using beam splitters and two radiation detectors fitted with filters.
3. The measured radiation reaches - without the beam-splitter - a double detector (sandwich design) fitted with filters. Here, the front detector represents the filter for the second detector behind it.

Using the pyrometer equations /5/ for channel 1 with wavelength λ_1 and channel 2 with λ_2 The result for the measured temperature T_{meas} :

$$1/T_{\text{meas}} = 1/T_{\text{target}} + (\lambda_1 \lambda_2)/(c_2 (\lambda_2 - \lambda_1)) \ln (\varepsilon_2/\varepsilon_1) \quad (3)$$

If the emissivity in both channels is the same, then the term after the plus sign becomes zero and the measured temperature corresponds to the target temperature T_{target} . (c_2 : second radiation constant in $\mu\text{m}\cdot\text{K}$).

The same can be applied to the target surface A , which as A_2 and A_1 is of course identical in the case of both channels, meaning that here too the term after the plus sign is dispensed with.

$$1/T_{\text{meas}} = 1/T_{\text{target}} + (\lambda_1 \lambda_2)/(c_2 (\lambda_2 - \lambda_1)) \ln (A_2/A_1) \quad (4)$$

Thus, the measurement is independent of the size of the target. Moreover, the object radiation being sent to the pyrometer becomes reduced proportionally, not only when there is a smaller measuring surface, but also when the pyrometer "gets to see" the target for a shorter time span. By this means, targets that are in the line of sight for a shorter period than the response time of the pyrometer can also be measured.

Changing transmittance characteristics in the measurement path are eliminated in the same way. The devices can be used where there is dust or smoke present, or any other interfering factor that reduces radiation from the target. Modern devices can apply this effect (attenuation) to their own optics, and send out an alarm signal at the appropriate level of contamination (e.g. air purge failure with the air-blowing attachment).

Special Pyrometers

In some applications where the nature of the technology means a certain particle density around the target, a ratio pyrometer with attenuation factor read-out can provide additional information. Fig. 26 shows the information given by a ratio pyrometer using PC software. In addition to the temperature calculated from the ratio, the measured temperatures from both individual channels are given. Moreover, attenuation that is calculated by comparing the two is displayed in percent.

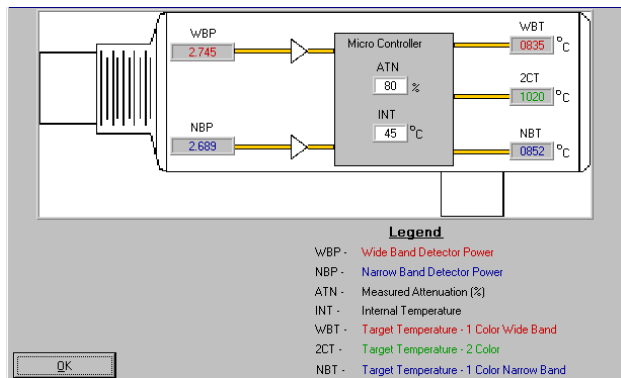

Fig. 26: Measuring data issued by PC software of a ratio pyrometer, e.g. target temperature in measuring channel 1 (WBT), target temperature in measuring channel 2 (NBT), and the target temperature calculated from the ratio (2CT). The measured attenuation is also displayed in percent (ATN) along with further information.

The following materials that have an oxidized surface behave as gray bodies and can be measured with a slope (relative emissivity) of 1.00:

Iron, Cobalt, Nickel, Steel, Stainless steel

The following materials that have a smooth, non-oxidized surface behave as non-gray bodies and are measured with a slope or relative emissivity of 1.06:

Iron, Cast iron, Cobalt, Nickel, Tungsten, Molybdenum, Steel, Stainless steel, Tantalum, Rhodium, Platinum

Summary

Ratio pyrometers can measure temperature when:

- 1. The target is smaller than the spot or is constantly changing in size (background cooler than target).*
- 2. The target moves through the spot within the response time.*
- 3. The line of sight to the target is restricted (dust or other particles, vapor or smoke).*
- 4. Emissivity changes during measurement.*

The attenuation factor provides additional information about the technological process or can be used as an alarm in the case of over-contamination of lenses or windows.

5.3 Imaging Systems

In contrast to the recording of temperature spots the temperature distribution on the target is of interest here. Local temperature differences as well as the detection of hot or cold spots often play a more important role than absolute temperature values. Fig. 27 shows the temperature differences of a plastic foil including a material defect on the right edge.

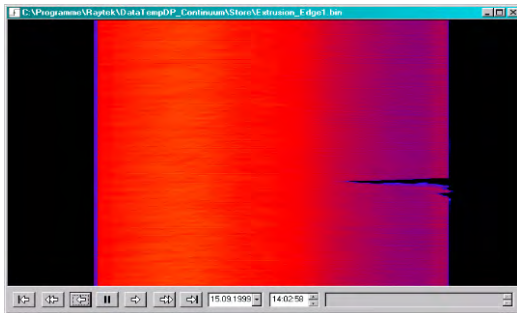

Fig. 27: Thermal image of a plastic foil with material defect on the right edge

The technical specifications of IR linescanners differ from those of pyrometers, because here often the whole angle of vision in degrees (e. g. 30°) and the angle relating to the measurement point (pixel) in mrad (e. g. 3 mrad) are indicated instead of the distance ratio (D:S). For a comparison with a single-spot pyrometer a conversion can easily be made using a measurement distance of one meter, since in this case the mrad indication of a measurement pixel is equivalent to the spot diameter in mm.

In addition the response time is replaced by the line/frame frequency.

5.3.1 IR Linescanners

IR linescanners are used for measuring moving targets, e. g. for conveyor or “web” processes. They display the temperature distribution diagonally to the moving direction. The movement of the process itself supplies the second coordinate for a complete thermal image. Fig. 28 demonstrates the measuring principle for a web process. Fig. 29 shows the temperature distribution across the foil and simultaneously the color presentation of the temperature values as a thermal image by joining several temperature profiles. The drop in temperature at the edges can clearly be seen.

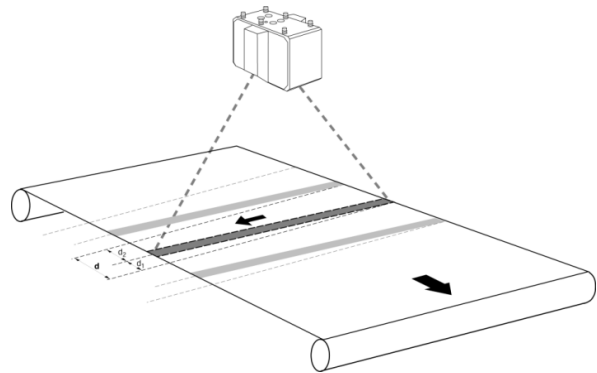

Fig. 28: Measuring principle of a line linescanner

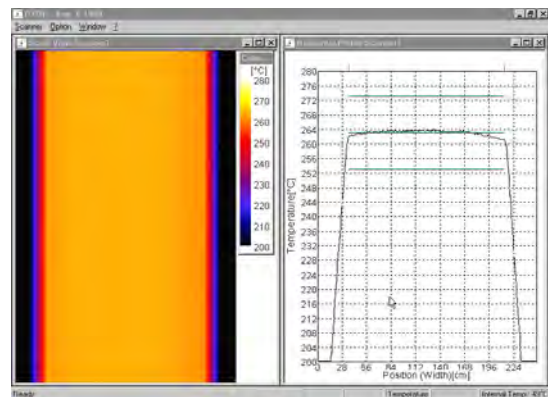

Fig. 29: Presentation of the measurement values of a linescanner while measuring foil web processes: thermal image (left) and thermal profile (right).

Opto-mechanical Systems

These systems use a spot sensor scanning the field of view using a moving mirror. This enables the generation of very accurate profiles since every point of the target is measured using the same sensor. As a rule, the opto-mechanical assembly defines the MTBF (*Mean Time between Failures*) of the measuring device. However, in view of today’s technology this value may be several years. Line frequencies amounting to several 100 Hz can be achieved and the number of measurement points can reach a maximum of 1000.

Special Pyrometers

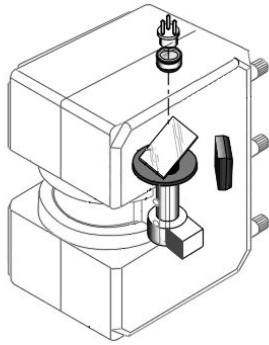

Fig. 30: Principle of an opto-mechanical assembly with rotational mirror

Since only one measurement point needs to be reproduced from the optical side, the optics can have a very simple design, in contrast to line sensor systems. This allows the implementation of low-cost systems. Another great advantage over line and matrix cameras is the broad visual angle which is formed by the entrance window in combination with the reflecting mirror unit. A visual angle of 90 degrees is no problem and thus allows practicable measurement distances even for broad web processes.

Line Sensor Systems

The number of measurement points is defined by the number of pixels of a line sensor. Thus no moving mirror is used. Since, as a rule, pyro-electrical sensor lines are used, and since this sensor only processes alternating light signals, the measurement signal has to be chopped by means of a special mechanical assembly. Thus, the MTBF of this measurement principle is defined by the opto-mechanical design, too. Calibration requires some additional work in order to compensate for the different pixel sensitivities, so that the so-called pattern noise, which can be seen e.g. when measuring a surface of homogenous temperature, will be as little as possible. This effect does not occur with the measuring system described in the previous chapter. Interchangeable optics are available which provide visual angles of a few degrees (telephoto lens) to a maximum of 60°.

5.3.2 Matrix Cameras

Matrix cameras can be designed completely without mechanically moving parts and provide a complete thermal image also from motionless targets. As a rule, cooled CMT matrixes from military research are used as matrixes (FPAs) for ultra high-speed cameras. Experiments using pyro-sensor matrixes have

been made for lower priced systems supplying video frequencies. However, today bolometer matrixes are widely used.

Bolometer FPAs

In recent years, in particular, much progress has been achieved with semiconductor-based bolometers. Noise-limited temperature resolution may be better than 0.1 K and frame frequencies achieve more than double of today's video standards. Today's standard systems offer a pixel resolution of 320x240 or full VGA resolution of 640x320 measurement points.

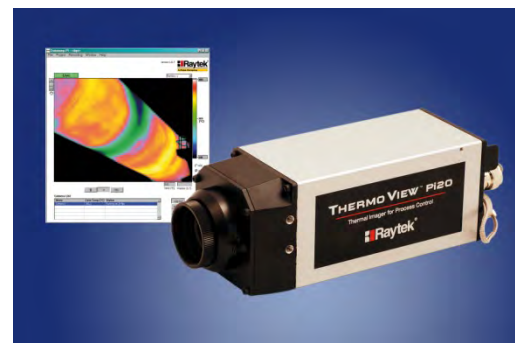

Fig. 31: Modern IR imaging camera with a pixel resolution of 320x240 (Raytek Thermoview Pi20)

6 Summary

Infrared thermometry measures the energy that is naturally emitted from all objects, without actually touching them. This allows quick, safe measurement of the temperature of objects that are moving, extremely hot, or difficult to reach. Where a contact instrument could alter the temperature, damage, or contaminate the product, a noncontact thermometer allows accurate product temperature measurement.

Compared to early infrared temperature measurement devices, which were heavy, awkward, and complicated to operate, the image of such devices today has completely changed. Modern infrared thermometers are small, ergonomic, easy to operate, and can even be installed into machinery. From versatile handheld devices to special sensors for integration into existing process systems, the spectrum of product offerings is vast.

7 Bibliography

- /1/ Klaus Herrmann, Ludwig Walther:
Wissensspeicher Infrarottechnik, 1990,
Fachbuchverlag Leipzig
- /2/ Stahl, Miosga: Grundlagen Infrarottechnik,
1980, Dr. Alfred Hütthig Verlag Heidelberg
- /3/ VDI/VDE Richtlinie, Technische Temperatur-
messungen – Strahlungsthermometrie,
January 1995, VDI/VDE 3511 page 4
- /4/ De Witt, Nutter: Theory and Practice of Radia-
tion Thermometry, 1988, John Wiley&Son,
New York, ISBN 0-471-61018-6
- /5/ Wolfe, Zissis: The Infrared Handbook, 1978,
Office of Naval Research,
Department of the Navy, Washington DC.
- /6/ VDI/VDE Richtlinie, Technische Temperatur-
messungen – Spezifikation von Strahlungsthe-
rмометern, June 2001,
VDI/VDE 3511 page 4.1
- /7/ VDI/VDE Richtlinie, Technische Temperatur-
messungen – Erhaltung der Spezifikation von
Strahlungstherмометern, January 2002,
VDI/VDE 3511 page 4.2
- /8/ VDI/VDE Richtlinie, Technische Temperatur-
messungen – Standard-Test-Methoden für
Strahlungstherмометern mit einem Wellenlän-
genbereich, July 2005, VDI/VDE 3511 page 4.3
- /9/ VDI/VDE Richtlinie, Technische Temperatur-
messungen – Kalibrierung von Strahlungsther-
мометern, July 2005, VDI/VDE 3511 page 4.4

Raytek Corporation

Raytek designs, manufactures and markets a complete line of infrared temperature measurement instruments for industrial, maintenance and quality control applications.

Raytek infrared temperature sensors are used worldwide in a broad range of applications where temperature plays an important role to ensure quality – whether in service trades, or in metal, glass and cement plants.

Raytek Automation sensors are integrated into industrial processes to provide continuous temperature monitoring. Our smart, digital systems allow process engineers to configure sensors and monitor temperatures remotely. From miniature, single-point sensors to sophisticated imaging systems with custom user interfaces, Raytek process sensors provide accurate, reliable temperature monitoring for demanding industrial processes.

Raytek industrial sensors deliver dependable, cost-effective, easy to use solutions for temperature monitoring. By decreasing down-time and waste and improving process efficiency and output, our products ensure immediate and substantial savings in time and money.

www.raytek.com

Worldwide Headquarters

Santa Cruz, CA USA

Tel: +1 800 227 8074 (USA/Canada)

+1 831 458 3900

solutions@raytek.com

European Headquarters

Berlin, Germany

Tel: +49 30 4780 080

Fax: +49 30 4710 251

raytek@raytek.de

China Headquarters

Beijing, China

Tel: +86 10 6438 4691

info@raytek.com.cn



The Worldwide Leader in Noncontact Temperature Measurement